

SINGLE BEAM SAFETY SENSORS SAFETY CONTROL UNITS

Installation Flexibility

Long distance

Low temperature with defogging function

4 safety areas controlled with one unit

Double muting

SENSORS:

- Emitter-receiver photocells with test input
- Type 2 and Type 4 models
- Plastic tubular and MAXI formats
- Up to 50m operating distance
- Class 1 red laser emission models up to 40
- Standard M12 connectors

CONTROL UNITS:

- Integrated control of 4 single beams and 2 light curtains
- Simple DIP Switch configuration
- Muting functions can be assigned to light curtains or single beams



APPLICATIONS

- Robots
- Automatic assembling lines
- Palletizers and Depalletizers

S5-5-G8-62-SG-ST2

EMITTER/RECEIVER

G8-62	Emitter
F8-92	Receiver

TYPE

2	Type 2
4	Type 4

SL5-5-G-82-SG-ST4

EMITTER/RECEIVER

G-82	Emitter
F-92	Receiver

S300-PR-5-G00-EX-M-SG-ST2

EMITTER/RECEIVER

G00-EX	Emitter
F00-OC	Receiver

DEFOGGING FUNCTION

...	Standard
M	Defogging

TYPE

2	Type 2
4	Type 4

TECHNICAL DATA

	S5	SL5	S300
GENERAL DATA			
Format	M18 Tubular		Rectangular
Light Emission	Infrared LED 880 nm	Class 1 Red laser (650 nm)	Infrared LED 880 nm
Type (EN61496-1)	2/4 depending on model	4	2/4 depending on model
Effective Aperture Angle (EN61496-2)	-/+ 2.5° for Type 4 models -/+ 5° for Type 2 models		
Operating distance	0 ... 8 m	0 ... 40 m	0 ... 50 m (S300...ST2) 9 ... 40 m (S300...ST4)
ELECTRICAL DATA			
Power supply (Vdc)	24 Vdc ± 15%		
Outputs	PNP (short circuit protection)		
Output current	100 mA max.		
Response time	1 ms max.		
MECHANICAL AND ENVIRONMENTAL DATA			
Operating temperature	-25 ... 55°C	-10 ... 50 °C	-40 ... 55 °C
Mechanical protection (EN 60529)	IP 67		
Housing Material	Polycarbonate, ABS		PBT
Window material	PMMA		Polycarbonate

	SG-BWS-T4	SG-BWS-T4-2	SG-BWS-T4-MT	SG-BWS-T4-2-MT
GENERAL DATA				
PL (EN ISO 13849-1)	e			
SIL (IEC 61508)	3			
ELECTRICAL DATA				
Power supply	24 Vdc -15/+10%			
PNP Outputs from S5/SL5/S300	4			
OSSDs couples from SLC	---			2
Muting inputs	---			4
Test, Reset, Override, EDM, Muting enable, Auto/Man Selector	3			9
Outputs				
Safety outputs	2 PNP			2 NO
Muting lamps	---			2
Test outputs	4			4
Response time ^A	29 ms	33 ms	35 ms	39 ms
MECHANICAL AND ENVIRONMENTAL DATA				
Operating temperature	0 ... +55°C			
Humidity	15 ... 95 % (no condensation)			
Mechanical protection	IP20			
FUNCTIONS ^B				
Single beams pairs (Rx/Tx) monitored	4	8	4	8
	Automatic/Manual reset			
	External Device Monitoring			
	---			L/T Muting
	---			Double muting
	---			Muting Enable
	---			Muting timeout
	---			Override
COMPATIBILITY				
Single beam photocells	S5/SL5/S300			
Safety light curtains	---			All DATALOGIC SLC

NOTES

^A includes response time of photocells

^B Functions setting is done through DIP switches in SG-BWS-T4-MT and through wiring in SG-BWS-T4

CONNECTIONS



DIMENSIONS (mm)

S5

S5-5-F8-SG-ST2

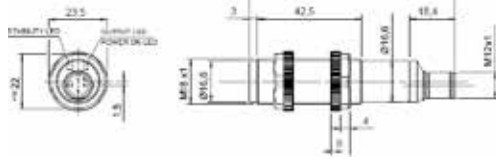

S5-5-G8-62-SG-ST2

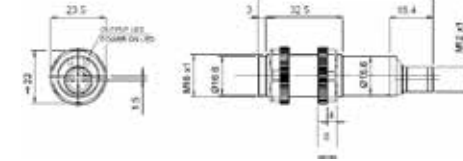

S5-5-F8-92-SG-ST4

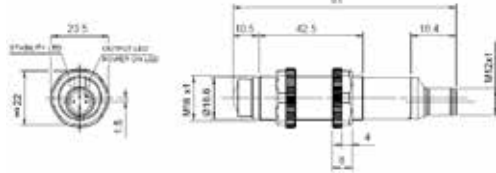

S5-5-G8-62-SG-ST4

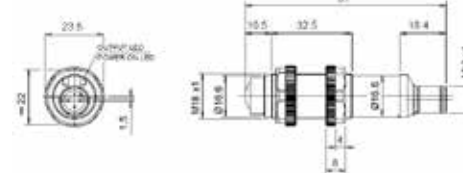

SL5

SL5-5-F-92-SG-ST4

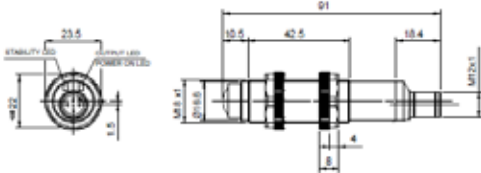

SL5-5-G-82-SG-ST4

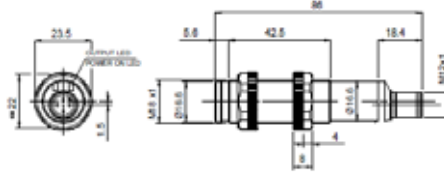

S300

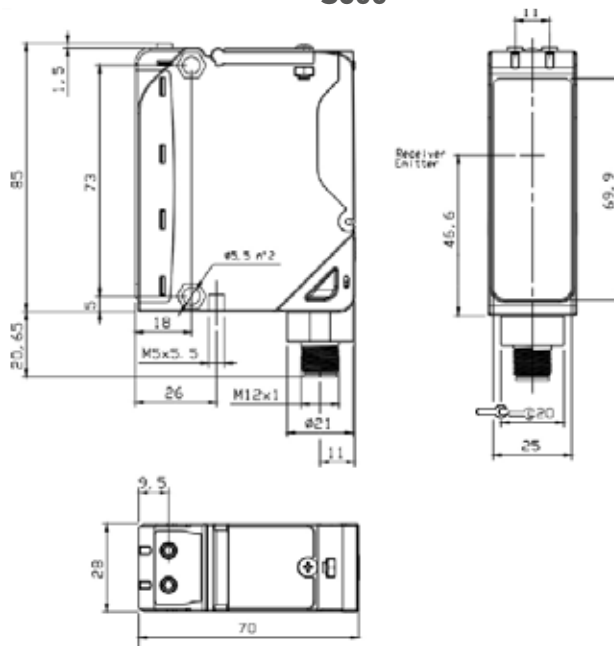

ACCESSORIES

MODEL	DESCRIPTION	ORDER NUMBER
SP-40	Fixed support for tubular M18 sensors	95ACC1370
SWING-18	Adjustable support for plastic tubular M18 sensors	895000006
MICRO-18	Support with micrometric regulation for tubular M18 sensors	95ACC1380
ST-5099	S300 Fixed bracket	95ACC2830
ST-5100	S300 Fixed bracket	95ACC2840
DataVS-MK-01	S300 Mounting kit	95A901380

ORDER CODES

SAFETY CONTROL UNITS		
MODEL	DESCRIPTION	ORDER NUMBER
SG-BWS-T4	Safety control unit pl=e auto/man edm, 4 beams	957051000
SG-BWS-T4-2	Safety control unit pl=e auto/man edm, 8 beams	957051030
SG-BWS-T4-MT	Safety control unit pl=e double muting, 4 beams	957051010
SG-BWS-T4-MT-2	Safety control unit pl=e double muting, 8 beams	957051040

SINGLE BEAM SAFETY SENSORS				
	TYPE	MODEL	EMITTER/RECEIVER	ORDER NUMBER
S5	2	S5-5-G8-62-SG-ST2	Emitter	952051870
		S5-5-F8-92-SG-ST2	Receiver	952051890
	4	S5-5-G8-62-SG-ST4	Emitter	952051910
		S5-5-F8-92-SG-ST4	Receiver	952051930
SL5	4	SL5-5-G-82-SG-ST4	Emitter	952501160
		SL5-5-F-92-SG-ST4	Receiver	952501170
S300	2	S300-PR-5-G00-EX-SG-ST2	Emitter	951451320
		S300-PR-5-F00-OC-SG-ST2	Receiver	951451340
	4	S300-PR-5-G00-EX-SG-ST4	Emitter	951451360
		S300-PR-5-F00-OC-SG-ST4	Receiver	951451380
S300 DEFOGGING	2	S300-PR-5-G00-EX-M-SG-ST2	Emitter	951451330
		S300-PR-5-F00-OC-M-SG-ST2	Receiver	951451350
	4	S300-PR-5-G00-EX-M-SG-ST4	Emitter	951451370
		S300-PR-5-F00-OC-M-SG-ST4	Receiver	951451390

1) The photocells listed above are certified and must be used only with safety control units SG-BWS-T4 and SG-BWS-T4-MT. Neither technical and functioning compatibility nor certifications are guaranteed if they are used with other brand control units or old/obsolete DATALOGIC control units.

CABLE ORDER CODES

MODEL	DESCRIPTION	ORDER NUMBER
CS -A1-02-U-03	4-pole M12 cable (axial) 3 m	95ASE 1120
CS -A1-02-U-05	4-pole M12 cable (axial) 5 m	95ASE 1130
CS -A1-02-U-10	4-pole M12 cable (axial) 10 m	95ASE 1140
CS -A1-02-U-15	4-pole M12 cable (axial) 15 m	95ASE 1150
CS -A1-02-U-25	4-pole M12 cable (axial) 25 m	95ASE 1160