

# SERIE OF/OFA

**DATALOGIC**

## GAMMA COMPLETA DI FIBRE OTTICHE: MODELLI UNIVERSALI O AVANZATI

- Modelli ultraflessibili
- Modelli per alte temperature (fino a 125 °C)
- Array di fibre a raggi paralleli per la rilevazione a tasteggio o proiettore/ ricevitore
- Tasteggi focalizzati con ottica assiale, radiale o laterale
- Tasteggi con ottica a 90° integrati
- Lenti focalizzatrici, collimatrici e deviaraggio

### APPLICAZIONI

- Macchinari per la lavorazione e l'imballaggio
- Assemblaggio elettronico
- Industria farmaceutica
- Industrie cosmetiche e dell'imbottigliamento

### OF/OFA

<b>Proiettore/ricevitore</b>	Le distanze operative sono influenzate da fattori come caratteristiche meccaniche, lunghezza e diametro della fibra ottica, nonché frequenze di commutazione, luce emessa e risoluzione dell'amplificatore per fibre ottiche. Per individuare la distanza operativa corretta fare riferimento ai manuali dei sensori.
<b>Tasteggio diffuso</b>	
<b>Focalizzato</b>	
<b>Diametro OF</b>	
<b>Testa OF</b>	M3, M4, M6
<b>Numero di raggi emessi OFA</b>	1, 16, 32
<b>Lunghezze cavo</b>	1, 2 m
<b>Temperatura di funzionamento</b>	-40...+60 °C (OF)
	-40...125 °C (OF-...-HT)
	-30...+70 °C (OFA)
<b>Materiale nucleo</b>	plastica PMMA
<b>Materiale guaina</b>	plastica PE
<b>Materiale terminale</b>	Alluminio (OFA-1/2) ABS (OFA-3/4) Acciaio inox (OFA-6)
<b>Protezione meccanica</b>	IP67

SERIE OF					
FUNZIONE OTTICA	TIPO DI FIBRA	LUNGHEZZA	TERMINALE	MODELLO	N° ORDINE
Proiettore/ricevitore	standard	1 m	M4x0.7 mm	OF-19-ST-10	S76021901
	standard	2 m	M4x0.7 mm *	OF-23-ST-20	S76022300
	sottile (Ø 1 mm)	1 m	M2x0.4 mm	OF-25-TN-10	S76022500
	standard	2 m	M4x0.7 mm	OF-43-ST-20	95A201350
	alta temperatura	2 m	M4x0.7 mm	OF-43-HT-20	95A201280
	ultra-flessibile	2 m	M4x0.7 mm	OF-43-UF-20	95A201290
	alta efficienza	2 m	M4x0.7 mm	OF-43-HP-20	95A201300
Tasteggio	standard	1 m	M6x1 mm	OF-18-ST-10	S76021801
	standard	2 m	M6x1 mm *	OF-22-ST-20	S76022200
	standard	2 m	M4x0.7 mm	OF-24-ST-20	S76022400
	sottile (Ø 1 mm)	1 m	M3x0.5 mm	OF-26-TN-10	S76022600
	sottile (Ø 1 mm)	1 m	M3x0.5 mm *	OF-28-TN-10	S76022800
	standard	2 m	Ø 3x15 mm	OF-38-ST-20	95A201070
	standard	2 m	M6x0.75 mm	OF-42-ST-20	95A201340
	alta temperatura	2 m	M6x0.75 mm	OF-42-HT-20	95A201250
	ultra-flessibile	2 m	M6x0.75 mm	OF-42-UF-20	95A201260
	alta efficienza	2 m	M6x0.75 mm	OF-42-HP-20	95A201270
Tasteggio Coassiale	standard	2 m	M6x1 mm	OF-36-ST-20	95A201000
	extra-flessibile	2 m	M6x1 mm	OF-36-XF-20	95A201330
	standard	2 m	M4x0.7 mm	OF-44-ST-20	95A201310
	extra-flessibile	2 m	M4x0.7 mm	OF-44-XF-20	95A201320

\* dal terminale fuoriesce un'estensione piegabile in acciaio inossidabile, lunga 90 mm



SERIE OFA					
FUNZIONE OTTICA	TIPO DI FIBRA	LUNGHEZZA	TERMINALE	MODELLO	N° ORDINE
Proiettore/ricevitore	assiale, array 16 raggi	2 m	15x15 mm	OFA-1-AE-20	95A201170
	radiale, array 16 raggi	2 m	15x15 mm	OFA-1-AS-20	95A201180
	radiale, array 16 raggi	2 m	19x38 mm	OFA-3-AS-20	95A201480
Tasteggio	assiale, array 32 raggi	2 m	20x20 mm	OFA-2-AE-20	95A201150
	radiale, array 32 raggi	2 m	20x20 mm	OFA-2-AS-20	95A201160
	radiale	2 m	5x65 mm	OFA-6-RA-20	95A201140
Tasteggio focalizzato	assiale	2 m	15x20 mm	OFA-4-FE-20	95A201200
	laterale	2 m	15x20 mm	OFA-4-FF-20	95A201210
	radiale	2 m	15x20 mm	OFA-4-FS-20	95A201190



ACCESSORI OF			
DESCRIZIONE	SUITABLE FIBERS	MODELLO	CODE N°
2 pz lenti deviaraggio a 90°	OF-43-XX	AF-1	95ACC2690
2 pz lenti collimatrici per lunga distanza (x 4)	OF-43-XX	AF-2	95ACC2700
1 pz lente focalizzatrice risoluzione 4 mm	OF-44-XX	AF-3	95ACC2710
1 pz lente focalizzatrice risoluzione 0,4 mm	OF-44-XX	AF-4	95ACC2720
2 pz adattatori Ø 2,2 mm per fibre sottili	OF-XX-TN	AF-5	95ACC2730
1 pz guaina metallica per fibre M6 x 0,75	OF-42-XX	AF-7	95ACC2750
1 pz guaina metallica per fibre M4 x 07	OF-43-XX (*)	AF-9	95ACC2770
utensile taglia-fibre con fori Ø 2,2 mm e Ø 1,1 mm	TUTTE	AF-11	95ACC2780

\* per entrambe le sezioni proiettore-ricevitore è necessario ordinare 2 guaine

## SERIE OF

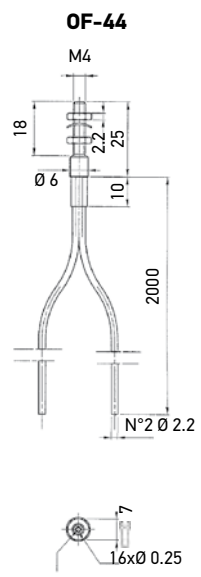
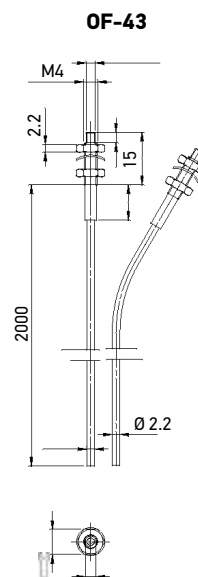
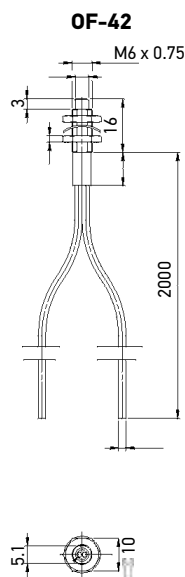
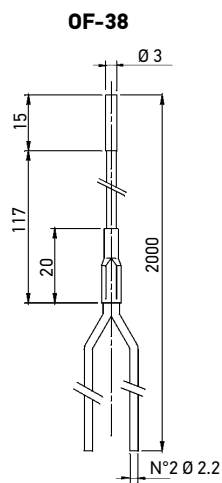
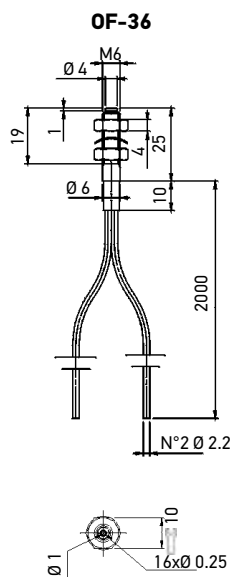
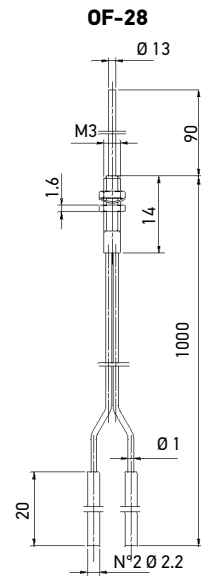
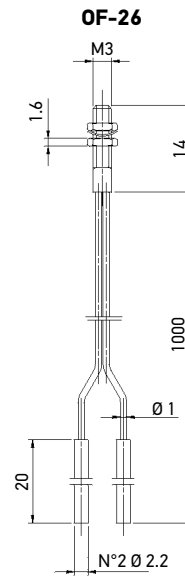
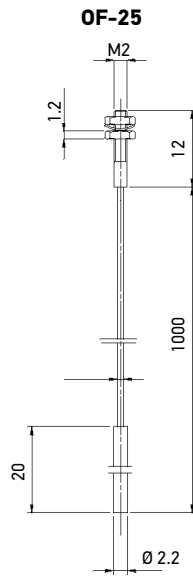
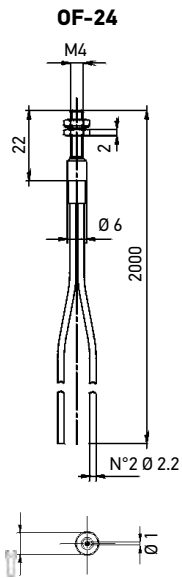
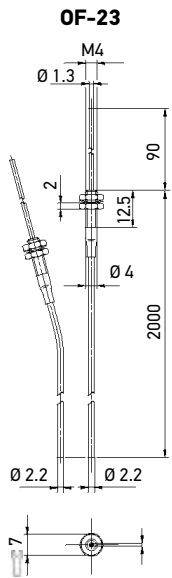
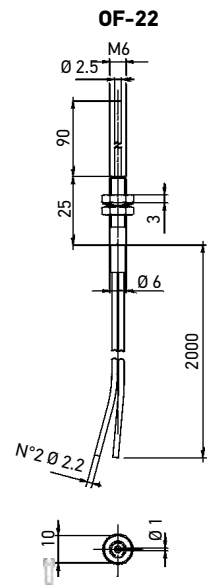
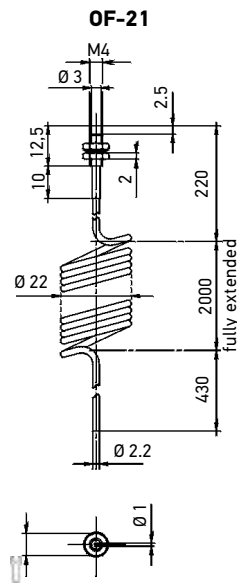
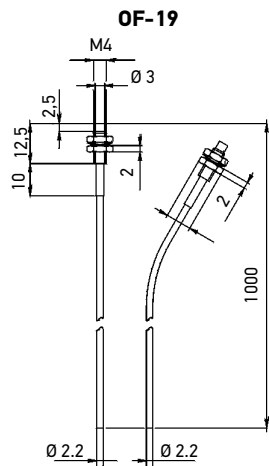
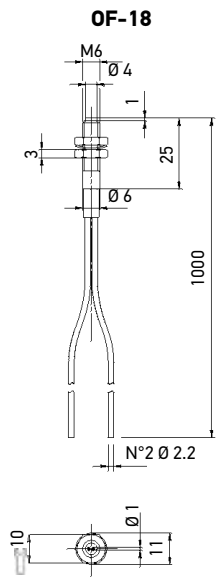

mm

# SERIE OFA

**OFA-1-AE-20**

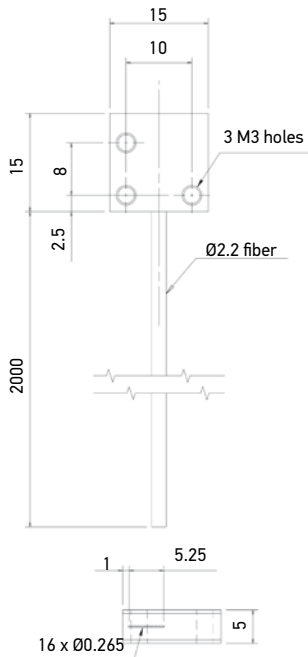

**OFA-1-AS-20**

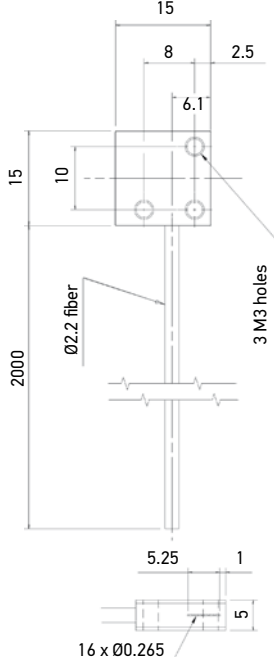

**OFA-2-AE-20**

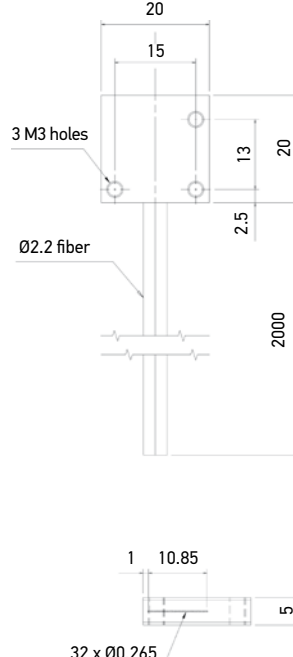

**OFA-2-AS-20**

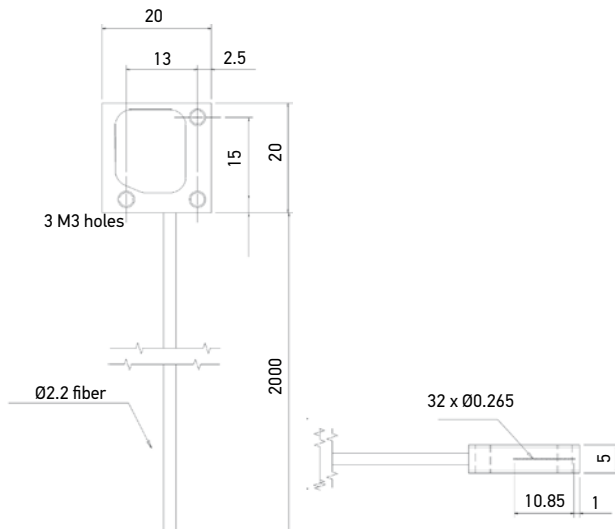

**OFA-3-AS-20**

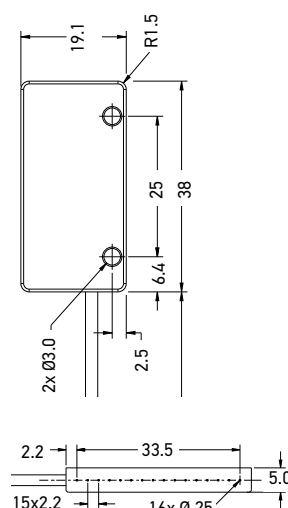

**OFA-4-FE-20**

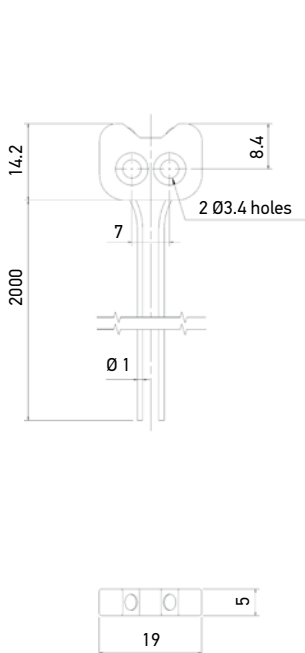

**OFA-4-FF-20**

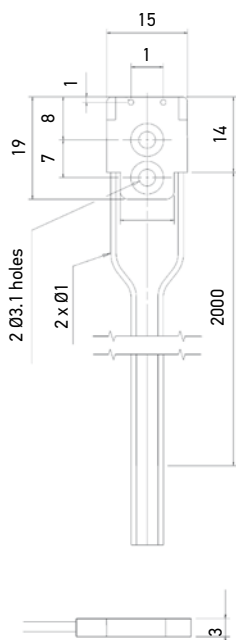

**OFA-4-FS-20**

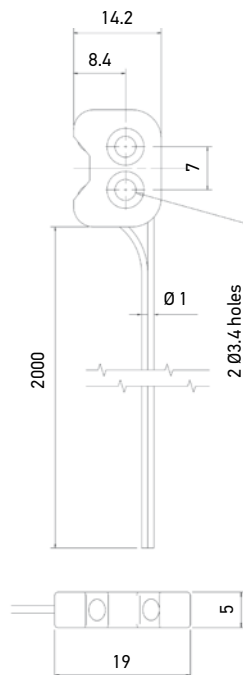

**OFA-6-RA-20**

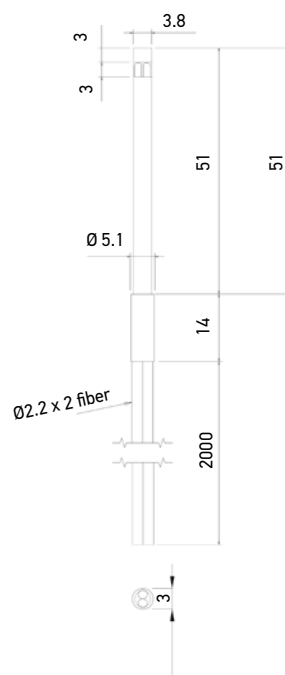

mm

# DIAGRAMMA DI RILEVAZIONE

