

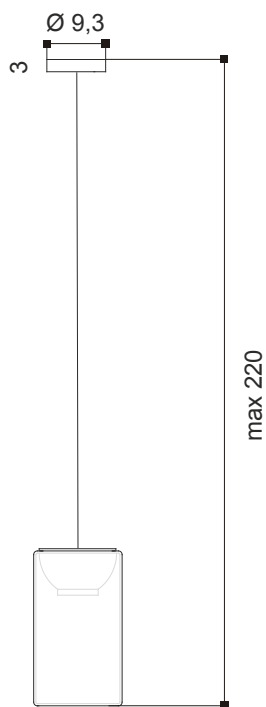

modello: model:	<b>PRÊT-À-PORTER</b>
codice: code:	<b>1516</b>
design:	<b>F. Rienzi</b>
anno - year:	<b>2013</b>
tipologia: typology:	<b>lampada a sospensione suspension lamp</b>
materiali: materials:	<b>vetro Pyrex trasparente con inserto in pellicola transparent Pyrex lamp with film insert</b>
luce: light:	<b>diffusa diffuse</b>
sorgente luminosa: light sources:	<b>12W E27 LED</b>
grado IP - IP grade:	<b>20</b>
peso netto - net weight:	<b>1,00 Kg</b>
finiture: finishes:	<b>.01 inserto bianco .02.21 inserto nero/interno dorato lucido .01 white insert .02.21 black insert/shiny gold inside</b>
marcatura: marking:	<b>CE</b>
simboli costruttivi: symbols:	<b>F R</b>

## Dimensioni - Dimensions



## Dimensioni del diffusore - Diffuser dimensions

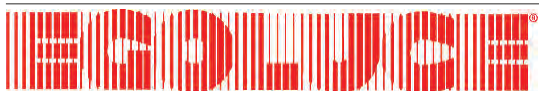
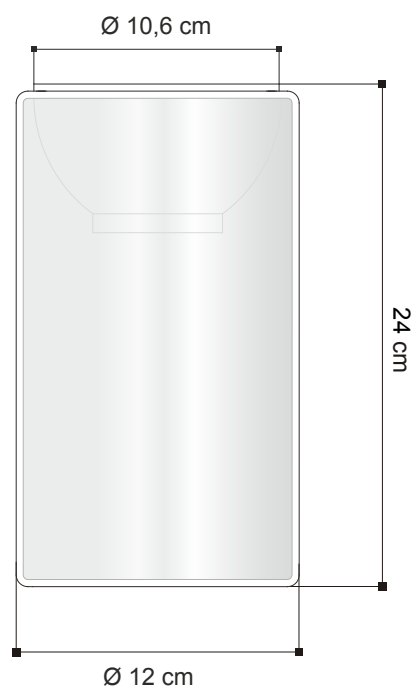

EGOLUCE s.r.l., via I. Newton 12 - 20016 Pero - Milano  
 telefono +39 02 339586.1 - fax. +39 02 3535112  
 e-mail: info@egoluce.com - http://www.egoluce.com

**Accessori** - rosoni lampada singola - **Accessories** - single lamp ceiling rose**0604**Rosone senza interruttore 1 uscita laterale  
**1 Egotube** - 50/60Hz 220-240VCeiling rose without switch 1 side hole  
**1 Egotube** - 50/60Hz 220-240V

- .01** Bianco - *White*  
**.02** Nero - *Black*

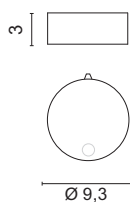

0,15 Kg

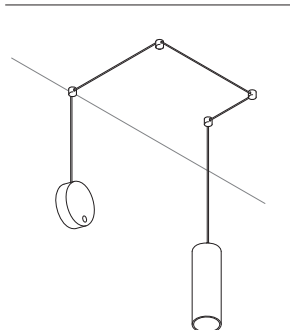
N° 1 art. 1660 - 1661 + 0604  
+ N° 4 art. 0605**0947**Piastra con molle per controsoffitti  
Ceiling plate with springs

- .01** Bianco - *White*  
**.02** Nero - *Black*  
**.35** Sabbia - *Sand*

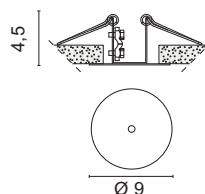

7,5 cm

0,08 Kg

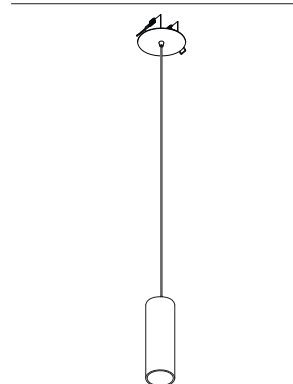

N° 1 art. 1660 - 1661 + 0947

**0607**Rosone in policarbonato per sospensione  
**1 Egotube** - 50/60Hz 220-240VPolycarbonate ceiling rose for suspension  
**1 Egotube** - 50/60Hz 220-240V

- .01** Bianco - *White*  
**.02** Nero - *Black*  
**.35** Sabbia - *Sand*

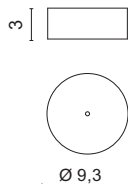

0,20 Kg

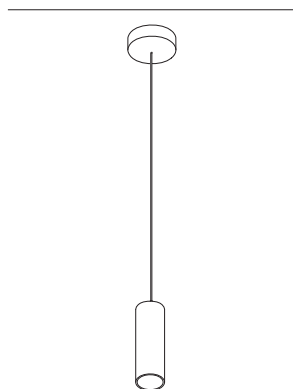

N° 1 art. 1660 - 1661 + 0607



N° 1 art. 1660 - 1661 + 0607

**0605**Deviatore e decentratore - Ø 1,7 H 2,2  
Displacement element - Ø 1,7 H 2,2

- .01** Bianco - *White*  
**.02** Nero - *Black*

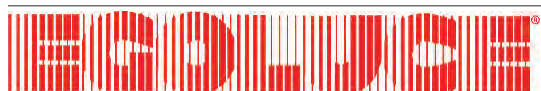
EGOLUCE s.r.l., via I. Newton 12 - 20016 Pero - Milano  
telefono +39 02 339586.1 - fax. +39 02 3535112  
e-mail: info@egoluce.com - http://www.egoluce.com

**Accessori - rosoni tondi multipli - Accessories - rounded ceiling rose****0600**

Rosone per sospensione  
**3 Egotube** - 50/60Hz 220-240V

Ceiling rose for suspension  
**3 Egotube** - 50/60Hz 220-240V

**.01** Bianco - *White*

**.02** Nero - *Black*

**.35** Sabbia - *Sand*

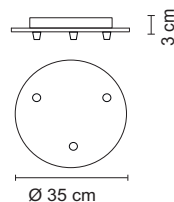

**F** 0,50 Kg

**0601**

Rosone per sospensione  
**5 Egotube** - 50/60Hz 220-240V

Ceiling rose for suspension  
**5 Egotube** - 50/60Hz 220-240V

**.01** Bianco - *White*

**.02** Nero - *Black*

**.35** Sabbia - *Sand*

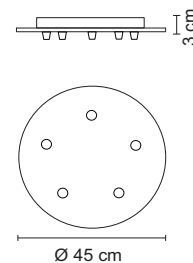

**F** 1,70 Kg

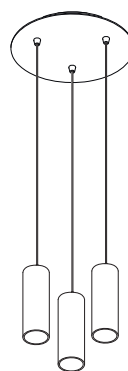

N° 3 art. 1560 - 1561 + 0600

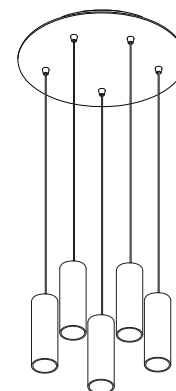

N° 5 art. 1560 - 1561 + 0601

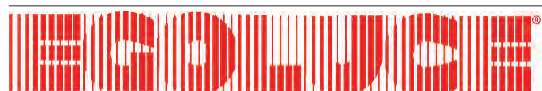

EGOLUCE s.r.l., via I. Newton 12 - 20016 Pero - Milano  
 telefono +39 02 339586.1 - fax. +39 02 3535112  
 e-mail: [info@egoluce.com](mailto:info@egoluce.com) - <http://www.egoluce.com>

**Accessori - rosoni quadrati multipli - Accessories - square ceiling rose**



N° 2 art. 1660 - 1661 + 0978/2

**0978/2** 2,00 Kg

Rosone per sospensione  
**2 Egotube** 50/60Hz 220-240V

Ceiling rose for suspension  
**2 Egotube** 50/60Hz 220-240V

.01 Bianco - White

.02 Nero - Black

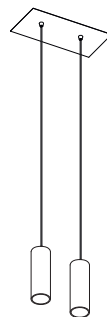
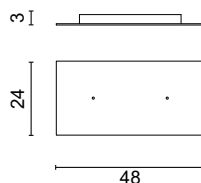

N° 2 art. 1660 - 1661 + 0978/2

**0978/4** 3,80 Kg

Rosone per sospensione  
**4 Egotube** 50/60Hz 220-240V

Ceiling rose for suspension  
**4 Egotube** 50/60Hz 220-240V

.01 Bianco - White

.02 Nero - Black

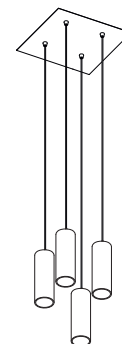
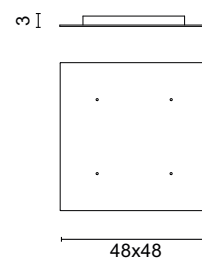

N° 4 art. 1660 - 1661 + 0978/4

**Esempio di installazione multipla - Example of multiple installation**

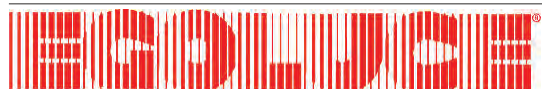
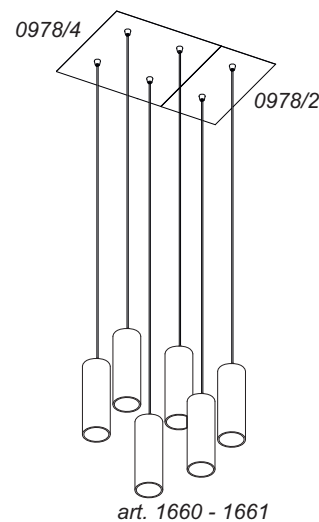
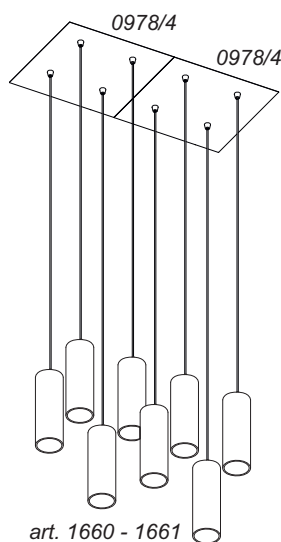
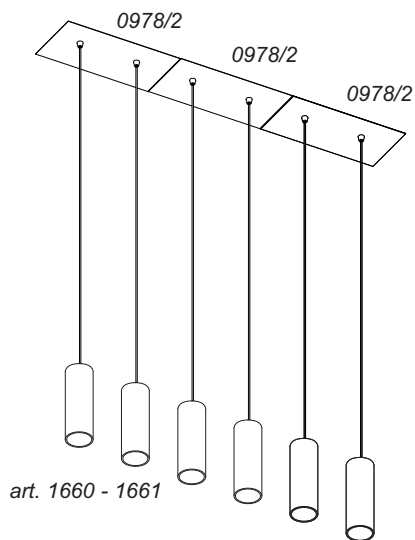

EGOLUCE s.r.l., via I. Newton 12 - 20016 Pero - Milano  
 telefono +39 02 339586.1 - fax. +39 02 3535112  
 e-mail: info@egoluce.com - http://www.egoluce.com

**Accessori - rosoni tondi multipli con uscita cavi radiali - Accessories - rounded ceiling rose with radial cable exit**



**0603**  
Rosone per sospensione  
**1 - 4 Egotube** - 50/60Hz 220-240V

Ceiling rose for suspension  
**1 - 4 Egotube** - 50/60Hz 220-240V

- .01 Bianco - White
- .02 Nero - Black

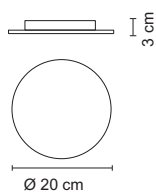

**F** 0,50 Kg



**0602**  
Rosone per sospensione  
**1 - 12 Egotube** - 50/60Hz 220-240V

Ceiling rose for suspension  
**1 - 12 Egotube** - 50/60Hz 220-240V

- .01 Bianco - White
- .02 Nero - Black

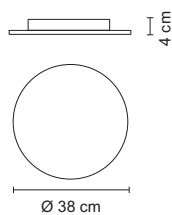

**F** 1,70 Kg



N° 3 art. 1660.01 + 0602.01

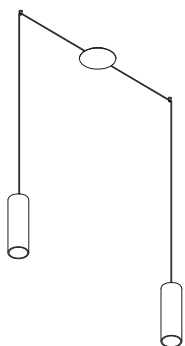

N° 2 art. 1660 - 1661 + 0603

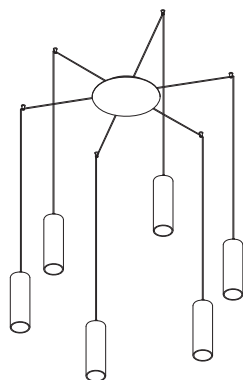

N° 6 art. 1660 - 1661 + 0602

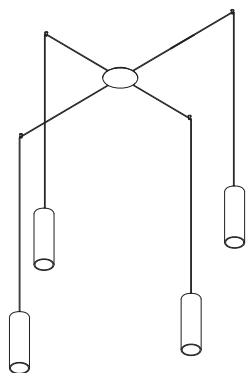

N° 4 art. 1660 - 1561 + 0603

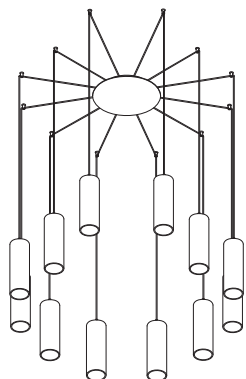

N° 12 art. 1660 - 1561 + 0602

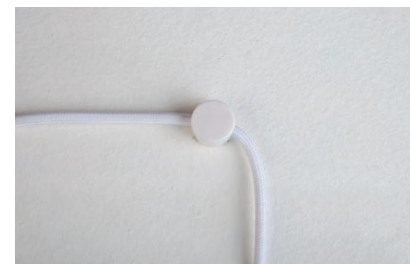

**0605**  
Deviatore e decentratore - Ø 1,7 H 2,2  
Displacement element - Ø 1,7 H 2,2

- .01 Bianco - White
- .02 Nero - Black

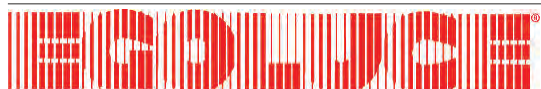

EGOLUCE s.r.l., via I.Newton 12 - 20016 Pero - Milano  
telefono +39 02 339586.1 - fax. +39 02 3535112  
e-mail: info@egoluce.com - http://www.egoluce.com

Accessori - rosoni lineari - **Accessories - linear ceiling rose**



N° 3 art. 1661 + 0559/3.01

**0613/3**

- .01** Bianco - White
- .02** Nero - Black
- .35** Sabbia - Sand

Rosone lineare - **3 Egotube**  
 Linear ceiling rose - **3 Egotube**  
 50/60Hz 220-240V

 1,10 Kg

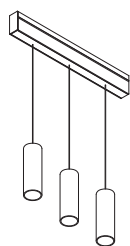
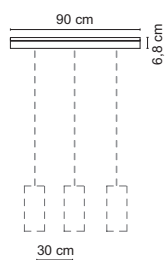

N° 3 art. 1660-1661 + 0613/3 ...

**0613/4**

- .01** Bianco - White
- .02** Nero - Black
- .35** Sabbia - Sand

Rosone lineare - **4 Egotube**  
 Linear ceiling rose - **4 Egotube**  
 50/60Hz 220-240V

 1,30 Kg

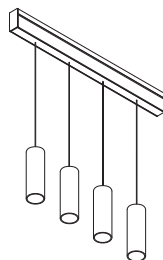
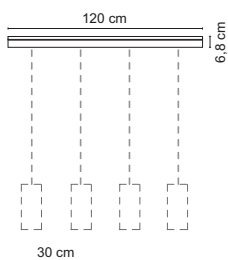

N° 4 art. 1660-1661 + 0613/4 ...

**0613/6**

- .01** Bianco - White
- .02** Nero - Black
- .35** Sabbia - Sand

Rosone lineare - **6 Egotube**  
 Linear ceiling rose - **6 Egotube**  
 50/60Hz 220-240V

 1,50 Kg

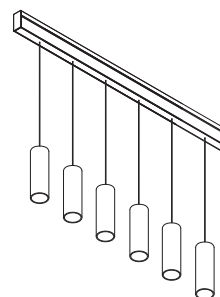
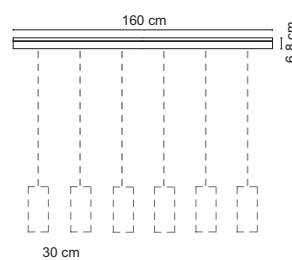

N° 6 art. 1660-1661 + 0613/6 ...

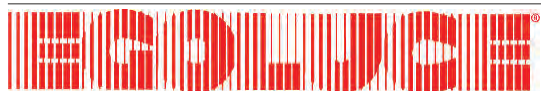

EGOLUCE s.r.l., via I.Newton 12 - 20016 Pero - Milano  
 telefono +39 02 339586.1 - fax. +39 02 3535112  
 e-mail: info@egoluce.com - http://www.egoluce.com