

PROLINE 1710TP

Scheda tecnica

Descrizione Profilo minimale in termoplastica estruso adatto per installazione a plafone

Corpo Termoplastica bianca o nera

Finiture disponibili Bianco White Nero Black

Diffusore Opale - Trasparente

Grado IP IP20

Marchi e garanzie

Norme IEC 60598-1

Marchio

Garanzia 2 anni

AVVERTENZE **Potere dissipante fino a 16W**

INFIAMMABILITA' **UI94 (Internale Test) Class V 0**
Classe di autoestinguenza V0 (o V-0) :
 Il materiale testato si spegne autonomamente entro 10 secondi dopo la rimozione del fuoco dal provino che viene posizionato verticalmente. E' possibile lo sgocciolamento di particelle di materiale fuso, purchè non si tratti di materiale infiammato.



CODICE PER KIT FINITO (esclusa strip LED)

Kit composto da: Profilo + tappi + diffusore + sistema di fissaggio
 Kit composed of: profile + caps + diffuser + fixing system



cod. BASE	Copertura Cover	Finitura profilo Profile finishing	Lunghezza profilo Profile length
1710TP -
	Trasparente Clear T	Bianco; White	01 2000 mm; L20
	Opale; Opal; O	Nero. Black	02 4000 mm; L40



DISEGNO TECNICO - mm -

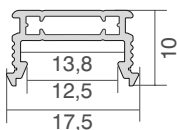

METODO DI INSTALLAZIONE INSTALLATION

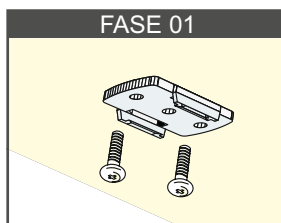

Installazione della staffa mediante le apposite viti in acciaio con tassello
 Clip installation through the specific steel screw

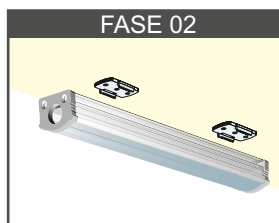

Allineare la barra alle staffe ed agganciarla a pressione.
 Align the profile to the clips and hook on pressure.

Numero di staffe consigliate per l'installazione:
 Suggested number of clips:

1000 mm	3 Pz.
2000 mm	6 Pz.

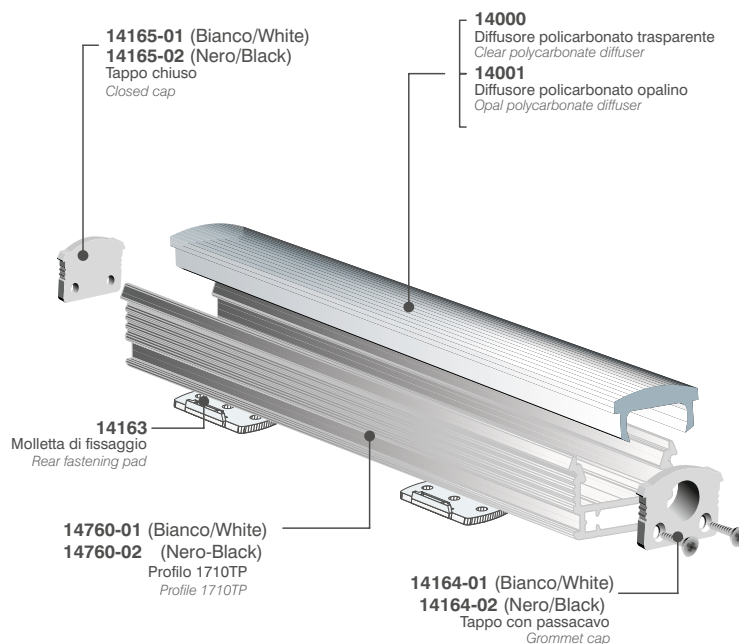

Optional

Codice
Code Descrizione
Description

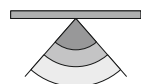

03102

Rilevatore di presenza
Presence detector



14071

Elettronica touch
ON/OFF e dimmer
Touch controller ON/OFF
/dimmer

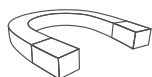

10075

1m di calamita di fissaggio
Fixing magnet 1 m



16100

1m Filtro Carne
1m Cool Meat filter

Per PANIFICI led b. caldo 2400K
Per PESCHERIA led b. freddo a 5800K

Accessori

Taglio ad angolo orizzontale 90°
Horizontal corner cut
Cod. **1710-A1**

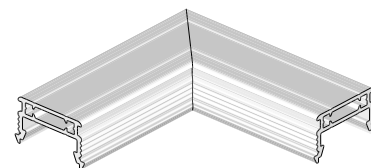

Taglio ad angolo verticale 90°
Vertical 90° corner cut
Cod. **1710-A2**

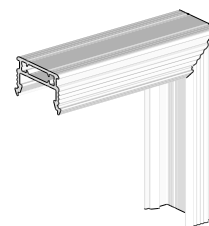

Taglio ad angolo verticale 270°
Vertical 270° corner cut
Cod. **1710-A3**

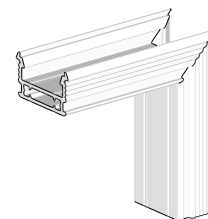

Molla per giunzione lineare
Linear junction clip
Cod. **1710-A4**

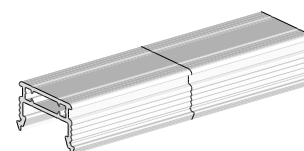

Strip compatibili

A.T series HI tech series Standards series

IP20		IP65		IP68	UL
flex 1350	4,9W	flex 1350	4,9W		
flex 650	4,5W	flex 650	4,5W		
flex 1330	6,5W	flex 1330	6,5W		
flex 960	9,6W	flex 960	9,6W		
flex 2550	9,9W	flex 2550	9,9W		
flex 1980	12,5W	flex 1980	12,5W		
flex 1200	14,4W				
flex 2850	14,9W	flex 2850	14,9W		