







I-Mago Alluminio - Corpo lampada



COD.	5510
LAMPADA	 LED / 3000K/4000K
LUMEN	750/ 380
W	7,5W / 230V/50Hz
IP	IP 65 
IK	IK10 (20 joules) /  Classe II
CERTIFICAZIONE	
CONFORMITÀ	EN 60598-1:2015 + EN 60598-2-1:1989
COLORI	
CLASSE ENERGETICA	

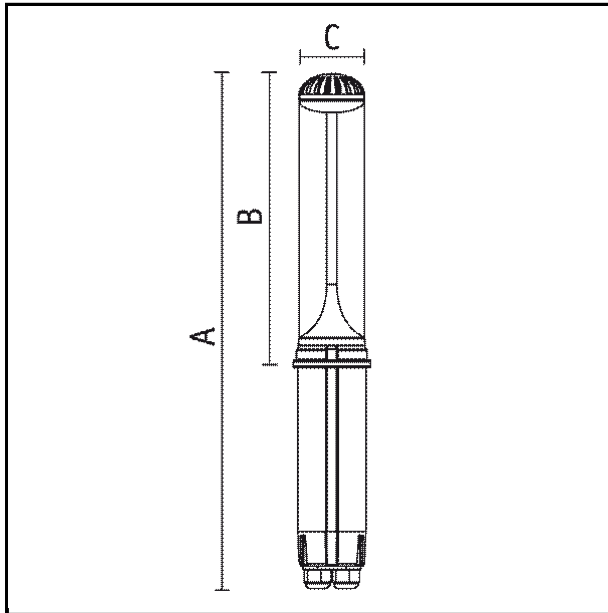

SPECIFICHE

- Diffusore in policarbonato trasparente
- Parti interne in alluminio satinato
- Scatola cablaggio in tecnopolimero
- 230V driver incorporato 500mA
- Gruppo di 4 led
- Vita: L80B20 60.000 h con decadimento max del 20%
- Altre tonalità di Led a richiesta

DIMENSIONI

- A 415 mm
- B 235 mm
- C 60 mm

Stampa creata il 04/06/2018 11:44

GOCCIA ILLUMINAZIONE s.r.l.

via E.Fermi, 59/65 | 25020 Poncarale (BS) Italy
Tel. +39.030.26.40.761 r.a. | Fax +39.030.26.40.271
www.goccia.it | info@goccia.it