



Contatore d'energia
applicazione di conteggio
secondario
6 moduli

Energy Meter
submetering
applications
6 module

Rete trifase 4 fili
Inserzione diretta:
230(400)V – 240(415)V 125A

Three-phase network, 4-wire
Direct connection:
230(400)V – 240(415)V 125A

Uscita impulsi programmabile
Comunicazione RS485
Morsettiere sigillabile

▶▶ Programmable pulse output
⊗ RS485 communication
Sealable terminals block

Interface esterne:
Comunicazione Ethernet (NT809-NT891)

External interfaces:
Ethernet communication (NT809-T891)

CONTO D6

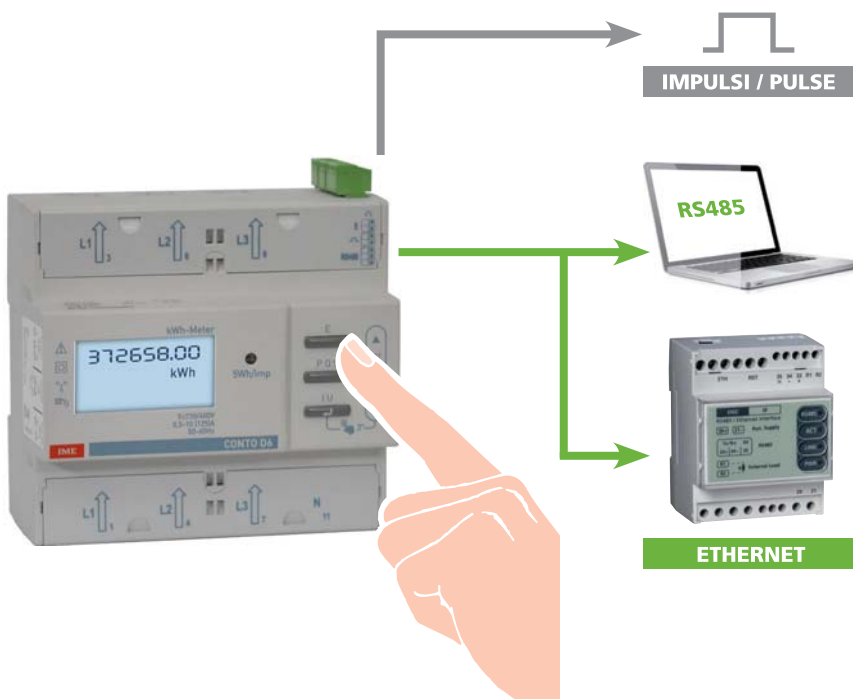

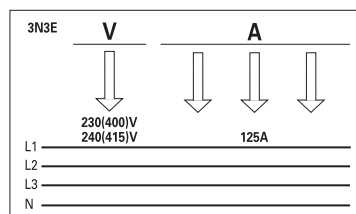

- ▶ **Energia Attiva Totale / Parziale**
Total / Partial Active Energy
- ▶ **Energia Attiva Tariffa 1 e 2**
Active Energy Tariff 1 and 2
- ▶ **Energia Reattiva Totale / Parziale**
Total / Partial Reactive Energy
- ▶ **Energia Reattiva Tariffa 1 e 2**
Active Energy Tariff 1 and 2
- ▶ **Ore - minuti di funzionamento**
Working hours and minutes
- ▶ **Corrente Istantanea**
Instantaneous Current
- ▶ **Potenza Istantanea e Media**
Max. Demand and Instantaneous Power
- ▶ **Tensione - Frequenza - Fattore di Potenza**
Voltage - Frequency - Power Factor



MODELLO MODEL		CONTO D6	
CODICE CODE		CE6DT125.	
LINEA NETWORK		bt / LV	
INGRESSO INPUT	CERTIFICAZIONE CERTIFICATION	MID	
	CONNESSIONE CONNECTION	Monofase / Single - phase	
		Trifase Three-phase	3 fili / wire
			4 fili / wire
	VALORI NOMINALI RATED VALUE	Tensione (fase-fase) Tensione (fase-fase)	400 - 415V
		Corrente Current	10 (125)A
	INGRESSO CORRENTE INPUT CURRENT	TA dedicati (shunt) Dedicated CT (shunt)	
Isolato / Insulated		✓	
RAPPORTO PROGRAMMABILE PROGRAMMABLE RATIO	TA / CT		
	TV / VT		
	Max. TA x TV Max. CT x VT		
ALIMENTAZIONE AUSILIARIA AUXILIARY SUPPLY	Autoalimentato / Selfsupplied	✓	
	230V ca / ac		
VISUALIZZAZIONE DISPLAY	ENERGIA ATTIVA ACTIVE ENERGY	Totale / Total	✓
		Parziale / Partial	✓
		Doppia tariffa / Double tariff	✓
		Precisione / Accuracy	cl.1 EN/IEC 62053-21
	ENERGIA REATTIVA REACTIVE ENERGY	Totale / Total	✓
		Parziale / Partial	✓
		Doppia tariffa / Double tariff	✓
		Precisione / Accuracy	cl.2 EN/IEC 62053-23
	TENSIONE VOLTAGE	di Fase / Phase	✓
		Concatenata / Linked	✓
	CORRENTE CURRENT	di Fase / Phase	✓
		di Neutro / Neutral	
POTENZA POWER	Attiva / Active	✓	
	Reattiva / Reactive	✓	
	Apparente / Apparent	✓	
	Attiva di fase / Phase Active	✓	
	Reattiva di fase / Phase Reactive	✓	
	Media / Max. demand Medio massiama / Peak max. demand	✓	
FREQUENZA FREQUENCY		✓	
FATTORE DI POTENZA POWER FACTOR	Trifase e per fase / Three-phase and for phase	✓	
CONTAORE RUN HOUR METER		✓	
DISPLAY	Retroilluminato / Backlit	✓	
USCITE OUTPUT	IMPULSI ENERGIA PULSE ENERGY		✓
	COMUNICAZIONE COMMUNICATION	RS485	CE6DT1256
		RS232	RS485 + IF
		M-Bus	
		Profibus	
Ethernet		RS485 + IF	

IF = Interfaccia esterna / External interface

CODICI CODE	USCITA OUTPUT	TENSIONE VOLTAGE	CORRENTE CURRENT	LINEA NETWORK
CE6DT1252	Impulsi energia <i>Energy pulses</i>	230(400)-240(415)V	10(125)A	4 Fili / wire
CE6DT1256	Impulsi energia + RS485 <i>Energy pulses + RS485</i>			





LEGENDA:  = Parametro Programmabile
 = Parametro Azzerabile

LEGEND:  = Programmable Parameter
 = Reset Parameter

VISUALIZZAZIONE

Tipo display: cristallo liquido 8 cifre
Altezza cifre: 6mm
Visualizzazione misure: suddivisa in menù e pagine
Scansione pagine: manuale, tramite pulsante frontale
Azzeramento parametri: manuale, tramite pulsante frontale
 Scansione pagine e azzeramento parametri

PAGINE ENERGIA

- Energia attiva e reattiva totale
- Energia attiva e reattiva tariffa 1
- Energia attiva e reattiva tariffa 2
-  Energia attiva e reattiva parziale
-  Valore massimo potenza attiva media
-  Valore massimo potenza attiva media tariffa 1
-  Valore massimo potenza attiva media tariffa 2

Potenza attiva media
 Contaore
 Tensioni, Correnti, Potenze
 Corrente di fase I1, I2, I3
 Tensione concatenata L1-2, L2-3, L3-1
 Potenza attiva, reattiva, apparente
 Frequenza
 Fattore di potenza

PROGRAMMAZIONE

Programmazione parametri: tastiera frontale, 3 tasti
Accesso alla programmazione: protetto da password
Conservazione dati e parametri di configurazione: memoria permanente (senza batteria)

INGRESSI DI MISURA

Linea trifase, 4 fili
Tensione trifase di riferimento: 3x230V / 400V c.a. ±15%
Autoconsumo circuito di tensione: Max. 1,5VA (1,5W) trifase
Frequenza di riferimento fn: 50-60Hz
Variatione ammessa: 47...63Hz
Corrente minima, Imin: 0,5A
Corrente di base, Ib: 10A
Corrente massima, Imax: 125A
Corrente di avviamento: 40mA
Sovracorrente di breve durata (EN62053-21, EN62053-23): 30Imax/10ms
Autoconsumo circuito di corrente: Max. 2,5W per fase
Fattore di potenza
Campo di funzionamento specificato (EN62053-21, EN62053-23):
 attiva cosφ 0,5 ind...0,8 cap, reattiva senφ 0,5 ind...0,5 cap
Fattore di distorsione corrente in accordo con EN62053-21

ALIMENTAZIONE AUSILIARIA

Alimentazione ausiliaria derivata dalla misura (autoalimentato)





ENERGIA

 Modalità di conteggio
Energia totale + energia parziale (sempre attivo)
Energia doppia tariffa (commutazione tariffa da contatto esterno)
Indicazione massima: 999999,99kWh / kvarh

DISPLAY

Type of display: LCD, 8 digit
Digit height: 6mm
Measurement display: subdivided on menus and pages
Page scrolling: manual, by front push-button
Parameter reset: manual, by front push-button
 Page scrolling and parameter reset

ENERGY PAGES

- Total active and reactive energy
- Active and reactive energy tariff 1
- Active and reactive energy tariff 2
-  Partial active and reactive energy
-  Active power max. demand
-  Active power max. demand tariff 1
-  Active power max. demand tariff 2

Active power demand
 Hour meter
 Voltage, Current, Powers
 Phase current I1, I2, I3
 Linked voltage L1-2, L2-3, L3-1
 Active, reactive, apparent power
 Frequency
 Power factor

PROGRAMMING

Parameters programming: front keyboard, 3 keys
Programming access: protected by password
Data and configuration parameters retention: non volatile memory (no battery)

MEASURE INPUTS

Three-phase, 4 wire network
Reference three-phase voltage: 3x230V / 400V a.c. ±15%
Power consumption in voltage circuit: Max. 1,5VA (1,5W) 3-phase
Reference frequency: 50-60Hz
Tolerance: 47...63Hz
Min. current, Imin: 0,5A
Basic current, Ib: 10A
Max. current, Imax: 125A
Starting current: 40mA
Short-time overcurrent (EN62053-21, EN62053-23): 30Imax/10ms
Power consumption in current circuit: Max. 2,5W per phase
Power factor
Specified operating range (EN62053-21, EN62053-23):
 active cosφ 0,5 ind...0,8 cap, reactive senφ 0,5 ind...0,5 cap
Current distortion factor according to EN62053-21

AUXILIARY SUPPLY

Taken from measurement (selfsupplied)

ENERGY



 Count mode
Total energy + partial energy (always active)
Double tariff energy (switching by external contact)
Maximum display: 999999,99kWh / kvarh

Risoluzione: 10Wh/varh
LED metrologico: 5Wh/imp.
Precisione energia attiva (EN/IEC 62053-21): classe 1
Precisione energia reattiva (EN/IEC 62053-23): classe 2
Inizio di funzionamento del contatore (EN/IEC 62053-21, EN/IEC 62053-23): < 5s

POTENZA MEDIA



Grandezza: potenza attiva per le 2 tariffe
Calcolo: media fissa, sul periodo selezionato
 **Tempo di media:** 5 – 8 – 10 – 15 – 20 – 30 – 60 minuti

CONTAORE



Conteggio: ore e minuti di funzionamento
Risoluzione: 7 cifre (5 ore + 2 minuti)
Indicazione massima: 99.999h 59min
 **Avvio conteggio:** potenza attiva trifase
 **Valore programmabile:** 0,4...50% Pn
(Potenza attiva trifase riferita a 400V 10A = 6,9kW)
 **Azzeramento conteggio:** accessibile da tastiera o inibito

INGRESSI / USCITE DIGITALI

• IMPULSI ENERGIA

Uscita impulsi compatibile con SO EN/IEC 62053-31
Optorelè con contatto SPST-NO libero da potenziale
Portata contatti: 27Vcc/ca – 50mA
 **Energia associabile:** energia attiva o reattiva
 **Peso impulso:** 1Wh/varh - 10Wh/varh – 100Wh/varh – 1kWh/kvarh – 10kWh/kvarh - 100kWh/kvarh
 **Durata impulso:** selezionabile 50 – 100 – 150 – 200 – 300 – 400 – 500ms

• COMUNICAZIONE RS485

Isolata galvanicamente da ingresso misura
Dati trasferiti: tutte le misure effettuate
Standard: RS485 – 3 fili
Trasmissione: asincrona seriale
Protocollo: compatibile ModBus RTU / ModBus TCP
 **N° indirizzo:** 1...255
Numero bit: 8
Bit di stop: 1
 **Bit di parità:** nessuna - pari - dispari
 **Velocità di trasmissione:** 4800 - 9600 – 19200 bit/secondo
Tempo di risposta a interrogazione: ≤ 200ms
N° massimo di apparecchi collegabili in rete: 32 (fino a 255 con ripetitore RS485)
Distanza massima dal supervisore: 1200m
Misure trasferite: vedi protocollo comunicazione

• SELEZIONE TARIFFA

Isolata galvanicamente
Tensione necessaria: 12-24V cc
Corrente assorbita: Max. 10mA

COMUNICAZIONE ETHERNET (NT809-NT891)

Realizzabile solo con i mod. CE6DT1256 (comunicazione RS485) + un' interfaccia IF2E o IF4E (RS485/Ethernet)

ISOLAMENTO

(EN62052-11, EN50470-1)

Categoria di misura: III
Grado di inquinamento: 2
Tensione di riferimento per l'isolamento: 300V Fase-terra
Prova di tensione a impulso 6kV 1,2/50µs
Circuiti considerati: ingresso di misura e I/O digitali
Prova a tensione alternata 4kV valore efficace 50Hz/1min
Circuiti considerati: ingresso di misura e I/O digitali
Prova a tensione alternata 4kV valore efficace 50Hz/1min
Circuiti considerati: tutti i circuiti e massa

Resolution: 10Wh/varh

Metering LED: 5Wh/pulse

Active energy accuracy (EN/IEC 62053-21): class 1



Reactive energy accuracy (EN/IEC 62053-23): class 2

Start-up time of the meter (EN/IEC 62053-21, EN/IEC 62053-23): < 5s

POWER DEMAND



Quantity: active power for two tariffs
Calculation: average on the selected time interval
 **Averaging time period:** 5 – 8 – 10 – 15 – 20 – 30 – 60 minutes

HOUR METER



Hour meter: working hours and minutes
Resolution: 7 digits (5 hours + 2 minutes)
Maximum display: 99.999h 59min
 **Count start:** three-phase active power
 **Programmable value:** 0,4...50% Pn
(three-phase active power, referred 400V 10A = 6,9kW)
 **Counter reset:** keyboard-accessible or inhibited

DIGITAL INUTS / OUTPUTS

• ENERGY PULSES

Pulse output compatible with SO EN/IEC 62053-31
Optorelay with potential-free SPST-NO contacts
Contact range: 27Vdc/ac – 50mA
 **Assignable energy:** active or reactive energy
 **Pulse weight:** 1Wh/varh - 10Wh/varh – 100Wh/varh – 1kWh/kvarh – 10kWh/kvar - 100kWh/kvarh
 **Pulse duration:** selectable 50 – 100 – 150 – 200 – 300 – 400 – 500ms

• RS485 COMMUNICATION

Galvanically insulated from input measurement
Transferred data: all the taken measurements
Standard: RS485 – 3-wire
Transmission: serial asynchronous
Protocol: compatible ModBus RTU / ModBus TCP
 **Address:** 1...255
Bit number: 8
Stop bit: 1
 **Parity bit:** none - even - odd
 **Baud rate:** 4800 - 9600 – 19200 bit/second
Required response time to request: ≤ 200ms
Meters that can be connected on the bus: 32 (up to 255 with RS485 repeater)
Highest distance from supervisor: 1200m
Transferred measurement: see communication protocol

• TARIFF SELECTION

Galvanically insulated
Necessary voltage: 12-24V dc
Absorbed current: Max. 10mA

ETHERNET COMMUNICATION (NT809-NT891)

By using only mod. CE6DT1256 (RS485 communication) + IF2E or IF4E (RS485/Ethernet) communication interface

INSULATION

(EN62052-11, EN50470-1)

Measure category: III
Pollution degree: 2
Insulation voltage rating: 300V Phase-earth
Impulse voltage test 6kV 1,2/50µs
Considered circuits: measuring input and digital I / O
A.C. voltage test 4kV r.m.s. 50Hz/1min
Considered circuits: measuring input and digital I / O
A.C. voltage test 4kV r.m.s. 50Hz/1min
Considered circuits: all circuits and earth

COMPATIBILITÀ ELETTROMAGNETICA

Prove in accordo con EN/IEC 62052-11 / EN50470-1

CONDIZIONI AMBIENTALI

Temperatura di riferimento: 23°C ± 2°C

Campo di funzionamento specificato: -25...55°C

Campo limite per l'immagazzinamento e trasporto: -25...70°C

Adatto all'utilizzo in climi tropicali

Massima potenza dissipata¹: ≤ 10W

¹ Per il dimensionamento termico dei quadri

CUSTODIA

Custodia: 6 moduli DIN 43880

Morsettiera sigillabile

Conessioni: morsetti a vite

Montaggio: a incastro su profilato 35mm







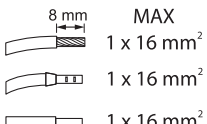

Tipo profilato: a cappello TH35-15 (EN60715)

Materiale custodia: poliamide autoestinguente

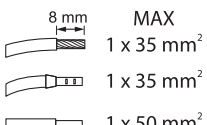
Grado di protezione (EN60529): IP54 frontale, IP20 morsetti

Peso: 500 grammi

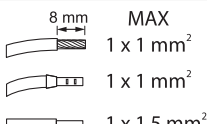
PORTATA MORSETTI TERMINALS POSITION

		MAX 1 x 16 mm ²	Recommended torque 1Nm 0,8 x 4mm 
		MAX 1 x 35 mm ² 1 x 50 mm ²	Recommended torque 3Nm COMBI PZ2 
 		MAX 1 x 1 mm ² 1 x 1,5 mm ²	Recommended torque 0,2Nm 0,5 x 2,5mm 

ELECTROMAGNETIC COMPATIBILITY

Test according to EN/IEC 62052-11 / EN50470-1

ENVIRONMENTAL CONDITIONS

Reference temperature: 23°C ± 2°C

Specified operating range: -25...55°C

Limit range for storage and transport: -25...70°C

Suitable for tropical climates

Max.power dissipation¹: ≤ 10W

¹ For switchboard thermal calculation

HOUSING

Housing: 6 module DIN 43880

Sealable terminals block

Connections: screw terminals

Mounting: snap-on 35mm rail

Rail type: top hat TH35-15 (EN60715)

Housing material: self-extinguishing polyamide

Protection degree (EN60529): IP54 front frame, IP20 terminals

Weight: 500 grams

POSIZIONE TERMINALI TERMINAL POSITION

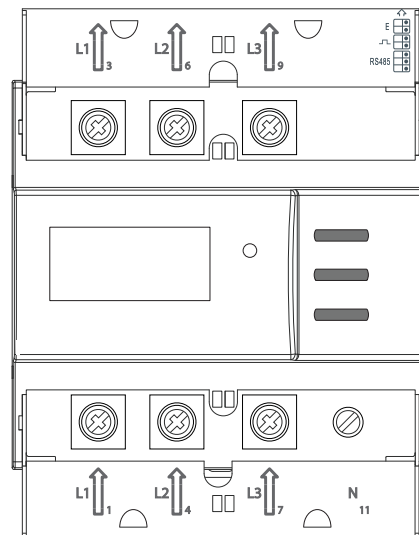

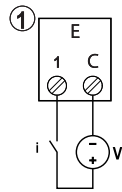
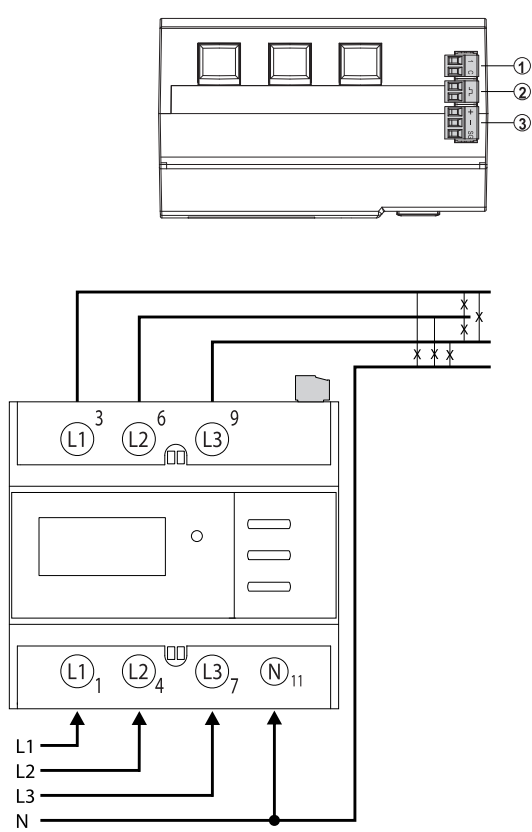

V: 12-24 VDC, max. 10 mA

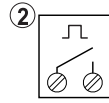

max. 27 V AC/DC, 50 mA

• Peso impulsi • Pulses weight: 10 Wh/imp.

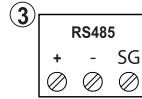

bus RS485 Modbus (CE6DT1256)

DIMENSIONI DIAGRAMS

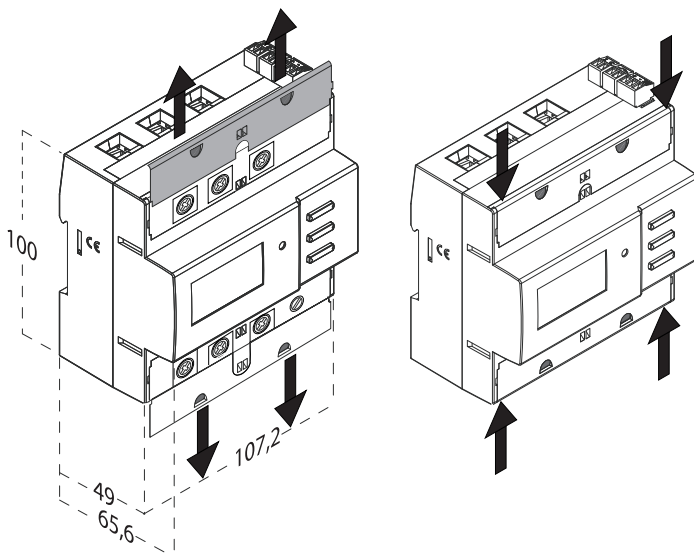

• Posizioni per la Piombatura • Positions for lead plating

