



Presentazione

Gamma prodotto	Harmony Timer Relays
Tipo prodotto	Multifunction relay
Tipo uscita digitale	Relè
Larghezza	17,5 mm
Nome dispositivo	RE17R
Tipo temporizzazione	Power on-delay Interval Ritardo alla diseccitazione Symmetrical flashing
Gamma di temporizzazione	6...60 min 1...10 min 1...10 s 1...10 H 6...60 s 0,1...1 s
Corrente di uscita nominale	8 A

Caratteristiche tecniche

Composizione e tipologia contatti	1 C/O
Materiale contatti	Senza cadmio
Altezza	90 mm
Profondità	72 mm
Tipo di comando	Selettore pannello frontale
Tensione nominale di alimentazione [Us]	24...240 V CA 50/60 Hz 24 V DC
Intervallo di tensione	0,85...1,1 Us
Frequenza di alimentazione	50...60 Hz +/- 5 %
Release of input voltage	10 V
Connessioni - morsetti	Morsetti a vite, 1 x 0,5...1 x 3,3 mm ² (AWG 20...AWG 12) solido senza estremità cavo Morsetti a vite, 2 x 0,5...2 x 2,5 mm ² (AWG 20...AWG 14) solido senza estremità cavo Morsetti a vite, 1 x 0,2...1 x 2,5 mm ² (AWG 24...AWG 14) flessibile con estremità cavo Morsetti a vite, 2 x 0,2...2 x 1,5 mm ² (AWG 24...AWG 16) flessibile con estremità cavo
Coppia di serraggio	0,6...1 Nm conforme a IEC 60947-1
Materiale involucro	Autoestinguento
Precisione ripetizione	+/- 0,5 % conforme a IEC 61812-1
Deriva di temperatura	+/- 0,05 %/°C
Deriva della tensione	+/- 0,2 %/V
Accuratezza regolazione temporizzazione	+/- 10% fondo scala a 25 °C conforme a IEC 61812-1
Control signal pulse width	100 ms con carico in parallelo tipica 30 ms tipica
Resistenza di isolamento	100 MΩ a 500 V CC conforme a IEC 60664-1
Tempo di reset	120 ms alla disattivazione tipica
Fattore di carico	100 %
Potenza assorbita in VA	0...32 VA a 240 V CA
Potenza assorbita in W	0,6 W a 24 V CC
Minima corrente di commutazione	10 mA a 5 V CC
Massima corrente di commutazione	8 A CA/CC

Massima tensione di commutazione	250 V CA
Potere di interruzione	2000 VA
Operating frequency	10 Hz
Durata elettrica	100000 cicli per resistivo carico (8 A a 250 V CA)
Durata meccanica	10000000 cicli
Resistenza dielettrica	2,5 kV 1 mA/1 minuto 50 Hz conforme a IEC 61812-1
Tensione nominale di tenuta ad impulso [Uimp]	5 kV durante 1,2/50 µs
Power on delay	100 ms
Marking	CE
Linea di fuga	4 kV/3 conforme a IEC 60664-1
Dati di affidabilità sicurezza	MTTFd = 296,8 anni B10d = 270000
Posizione di montaggio	Qualunque posizione in relation to normal vertical mounting plane
Supporto per montaggio	Guida DIN 35 mm conforme a EN/IEC 60715
Segnalazione locale	Indicatore LED per fisso: relè eccitato, nessuna temporizzazione in corso Indicatore LED 80% ON e 20% OFF per lampeggiante: temporizzazione in corso Indicatore LED 5% ON e 95% OFF per pulsing: relay de-energised, no timing in progress (except function Di-D, Li-L)
Peso prodotto	0,07 kg
Tipo di ritardo	A, At, B, C, D, Di, H, Ht
Funzionalità	Multifunction
Codice compatibilità	RE17

Ambiente

Immunità alle microinterruzioni	20 ms
Standard	2004/108/EC EN 61000-6-2 EN 61000-6-3 EN 61000-6-1 2006/95/EC IEC 61812-1 EN 61000-6-4
Certificazioni prodotto	CSA cULus
Temperatura di stoccaggio	-30...60 °C
Temperatura ambiente	-20...60 °C
Grado di protezione IP	IP20 conforme a IEC 60529 (blocco terminale) IP40 conforme a IEC 60529 (alloggiamento) IP50 conforme a IEC 60529 (pannello frontale)
Resistenza alle vibrazioni	20 m/s ² (F= 10...150 Hz) conforme a IEC 60068-2-6
Tenuta agli urti	15 gn per 11 ms conforme a IEC 60068-2-27
Umidità relativa	93 % senza condensa conforme a IEC 60068-2-30
Compatibilità elettromagnetica	Test immunità scarica elettrostatica: (in contatto) livello 3 6 kV conforme a IEC 61000-4-2 Test immunità scarica elettrostatica: (in aria) livello 3 8 kV conforme a IEC 61000-4-2 Susceptività ai campi elettromagnetici: (80 MHz a 1 GHz) livello 3 10 V/m conforme a IEC 61000-4-3 Prova di immunità ai transitori veloci / burst: (clip collegamento capacitivo) livello 3 1 kV conforme a IEC 61000-4-4 Prova di immunità ai transitori veloci / burst: (diretto) livello 3 2 kV conforme a IEC 61000-4-4 Test immunità onde d'urto 1,2/50 µs: (modo differenziale) livello 3 1 kV conforme a IEC 61000-4-5 Test immunità onde d'urto 1,2/50 µs: (modo comune) livello 3 2 kV conforme a IEC 61000-4-5 Disturbi RF condotti: (0,15...80 MHz) livello 3 10 V conforme a IEC 61000-4-6 Test immunità cali di tensione e interruzioni: (1 ciclo) 0 % conforme a IEC 61000-4-11 Test immunità cali di tensione e interruzioni: (25/30 cicli) 0.7 conforme a IEC 61000-4-11 Emissioni condotte e irradiate: classe B conforme a EN 55022

Confezionamenti

Unità di misura confezione 1	PCE
Numero di unità per confezione 1	1
Confezione 1: altezza	2,800 cm
Confezione 1: larghezza	7,800 cm
Confezione 1: profondità	9,600 cm
Confezione 1: peso	78,000 g
Unità di misura confezione 2	S02
Numero di unità per confezione 2	40
Confezione 2: altezza	15,000 cm
Confezione 2: larghezza	30,000 cm
Confezione 2: profondità	40,000 cm
Confezione 2: peso	3,740 kg

Sostenibilità dell'offerta

Stato offerta sostenibile	Prodotto Green Premium
Regolamento REACH	Dichiarazione REACH
Direttiva RoHS UE	Conformità proattiva (prodotto al di fuori dell'ambito legale di RoHS Unione europea) EU RoHS Dichiarazione
Senza mercurio	Sì
Regolamento RoHS della Cina	Dichiarazione RoHS Della Cina
Informazioni esenzioni RoHS	Sì
Informazioni ambientali	Profilo Ambientale Del Prodotto
Profilo di circolarità	Informazioni Sulla Fine Della Vita

Garanzia contrattuale

Garanzia	18 mesi
----------	---------

Width 17.5 mm

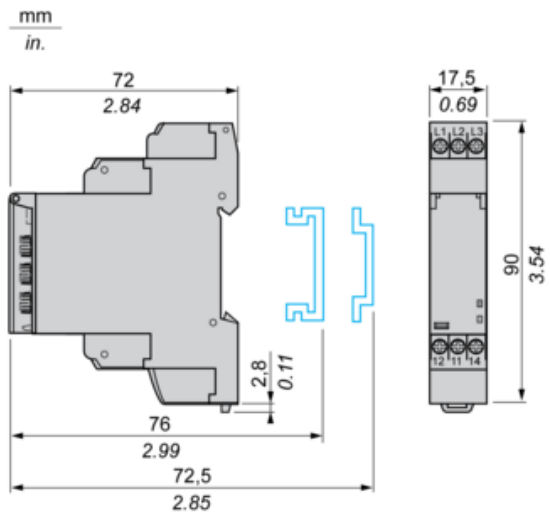

Internal Wiring Diagram

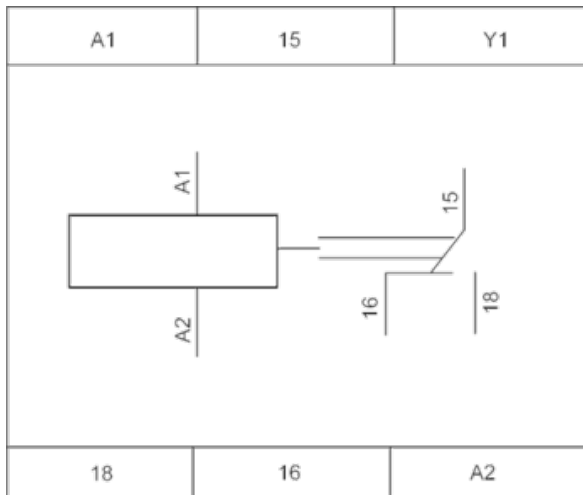

Wiring Diagram

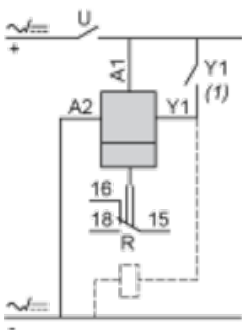

1) Contact Y1:

- Control for functions B, C, Ac, Bw, Ad, Ah, N, O, W, T, Tt.
- Partial stop for functions At, Ht and Pt.
- Function D if Di selected.
- Not used for functions A, H and P.

Function A : Power on Delay Relay

Description

The timing period T begins on energisation. After timing, the output(s) R close(s). The second output can be either timed or instantaneous.

Function: 1 Output



Function: 2 Outputs

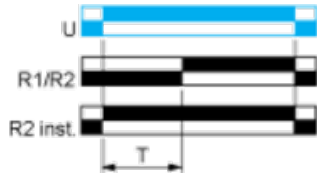

2 timed outputs (R1/R2) or 1 timed output (R1) and 1 instantaneous output (R2 inst.)

Function At : Power on Delay Relay (Summation) with Control Signal

Description

After power-up, the first opening of control contact C starts the timing. Timing can be interrupted each time control contact closes. When the cumulative total of time periods elapsed reaches the pre-set value T, the output relay closes.

Function: 1 Output

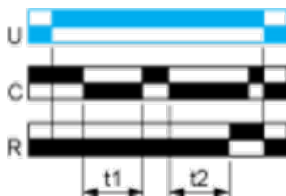

$T = t_1 + t_2 + \dots$

Function B : Interval Relay with Control Signal

Description

After power-up, pulsing or maintaining control contact C starts the timing T. The output R closes for the duration of the timing period T then reverts to its initial state.

Function: 1 Output

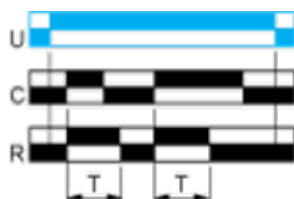

Function C : Off-Delay Relay with Control Signal

Description

After power-up and closing of the control contact C, the output R closes. When control contact C re-opens, timing T starts. At the end of the timing period, the output(s) R revert(s) to its/their initial state. The second output can be either timed or instantaneous.

Function: 1 Output

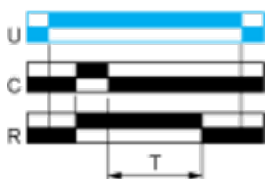

Function: 2 Outputs

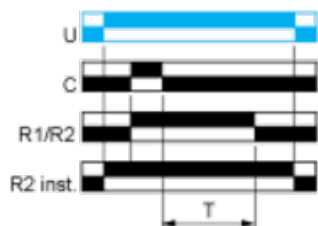

2 timed outputs (R1/R2) or 1 timed output (R1) and 1 instantaneous output (R2 inst.)

Function D: Symmetrical Flashing Relay (Starting Pulse Off)

Description

On energisation of power supply, output(s) R starts at its/their initial state for timing duration T then change(s) to output(s) R close(s) for the same timing duration T. This cycle is repeated indefinitely until power supply removal. Specially for RE17*, RE22R2AMU, RE22R2MMW, RE22R2MMU, RE22R2MJU, this D function can only be initiated by energizing Y1 permanently. The second output (R2) can be either timed (when set to "TIMED") or instantaneous (when set to "INST").

Function: 1 Output

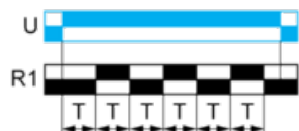

Function: 2 Outputs

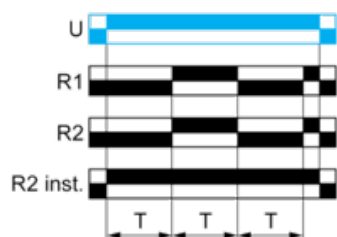

Function: 1 Output with Retrigger / Restart Control

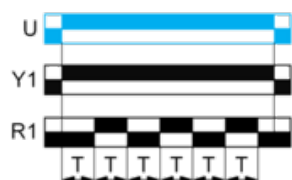

Function: 2 Output with Retrigger / Restart Control

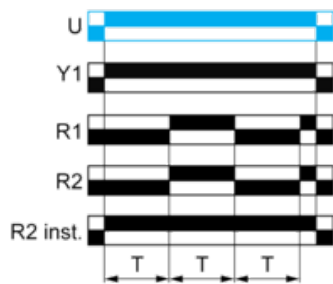

Function Di : Symmetrical Flasher Relay (Starting Pulse On)

Description

Repetitive cycle with two timing periods T of equal duration, with output(s) R changing state at the end of each timing period T. The second output can be either timed or instantaneous.

Function: 1 Output



Function: 2 Outputs

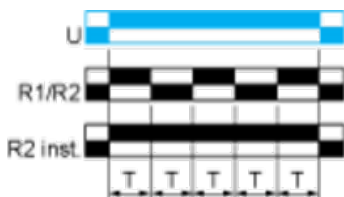

2 timed outputs (R1/R2) or 1 timed output (R1) and 1 instantaneous output (R2 inst.)

Function H : Interval Relay

Description

On energisation of the relay, timing period T starts and the output(s) R close(s). At the end of the timing period T, the output(s) R revert(s) to its/their initial state. The second output can be either timed or instantaneous.

Function: 1 Output



Function: 2 Outputs

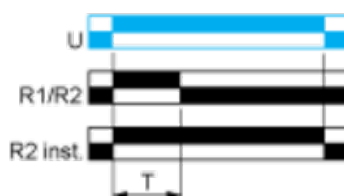

2 timed outputs (R1/R2) or 1 timed output (R1) and 1 instantaneous output (R2 inst.)

Function Ht: Interval Relay & With Pause / Summation Control

Description

On energisation of power supply, output(s) R close(s) and timing period T starts.

The timing can be interrupted / paused each time X1 energizes.

When the cumulative total of time periods elapsed reaches the pre-set value T, the output(s) R revert(s) to its/their initial state Reenergization of X1 will also cause output(s) R close(s) if the time has elapsed and restart the same operation as described at the beginning.

Except for RE17*, RE22R2MMW, RENF22R2MMW, RE22R2MMU and RE22R2MJU, timing can be interrupted / paused each time Y1 energizes.

The second output (R2) can be either timed (when set to "TIMED") or instantaneous (when set to "INST").

Function: 1 Output

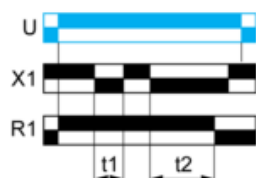

$$T = t1 + t2 + \dots$$

Function: 2 Outputs

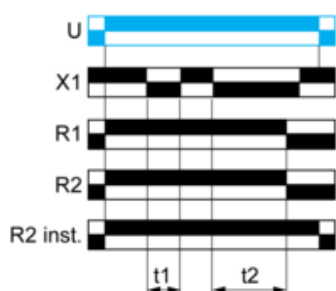

$$T = t1 + t2 + \dots$$

Function: 1 Output with Retrigger / Restart Control

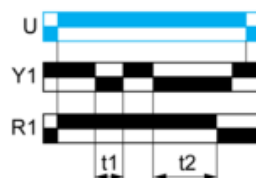

$$T = t1 + t2 + \dots$$

Function: 2 Outputs with Retrigger / Restart Control

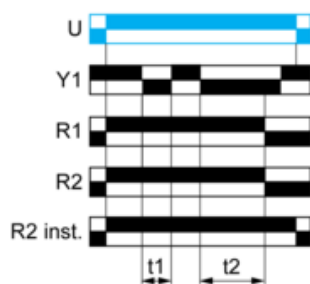

$$T = t1 + t2 + \dots$$

Legend

Relay de-energised

Relay energised

 Output open

 Output closed

C	Control contact
---	-----------------

G	Gate
R	Relay or solid state output
R1/R2	2 timed outputs
R2 inst.	The second output is instantaneous if the right position is selected
T	Timing period
Ta -	Adjustable On-delay
Tr -	Adjustable Off-delay
U	Supply